



“Progetto per Gorla Minore”

arch. Paolo Aina

ICT Angelo Torretta S.p.A.



Contesto

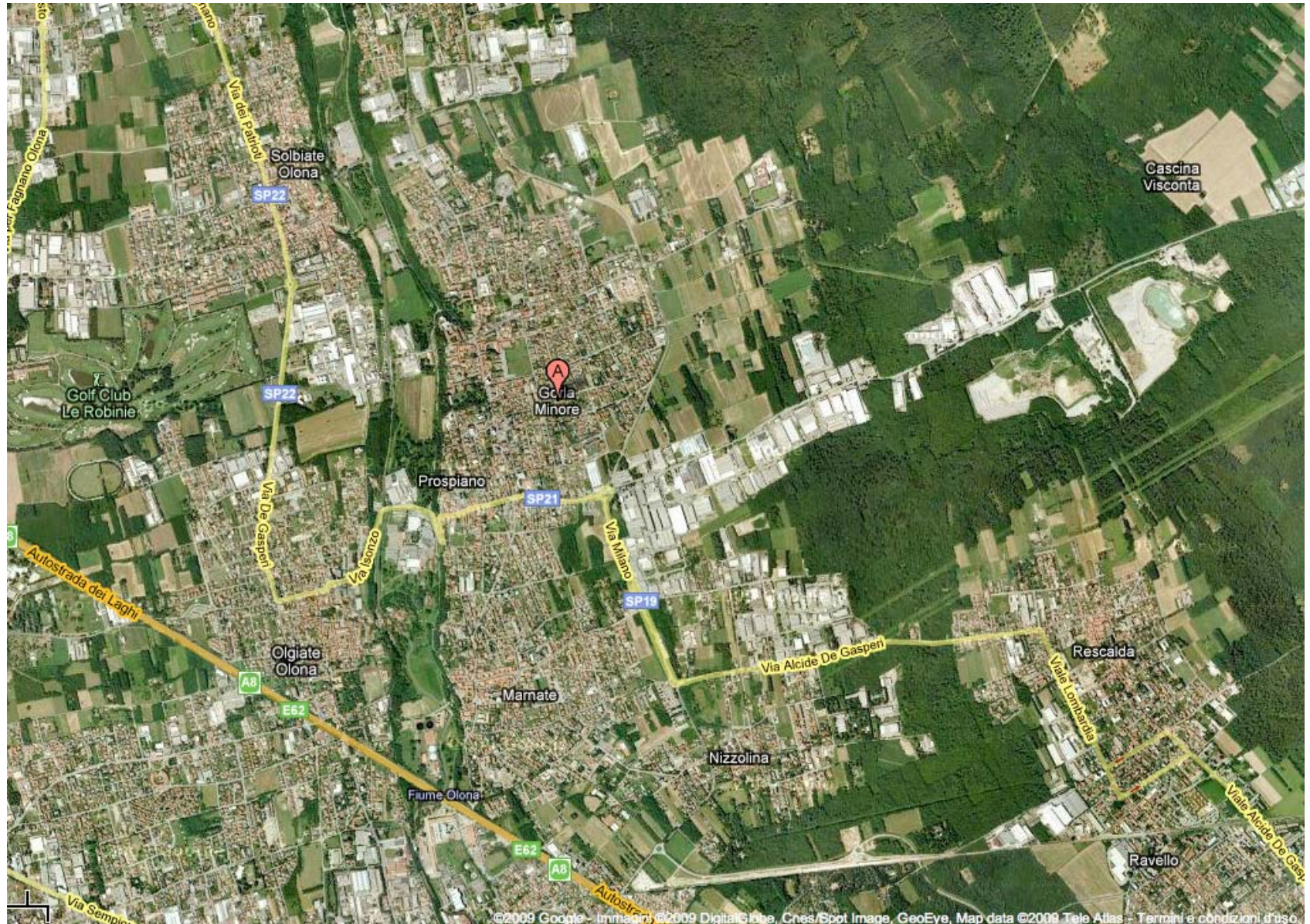

Localizzazione dell'intervento





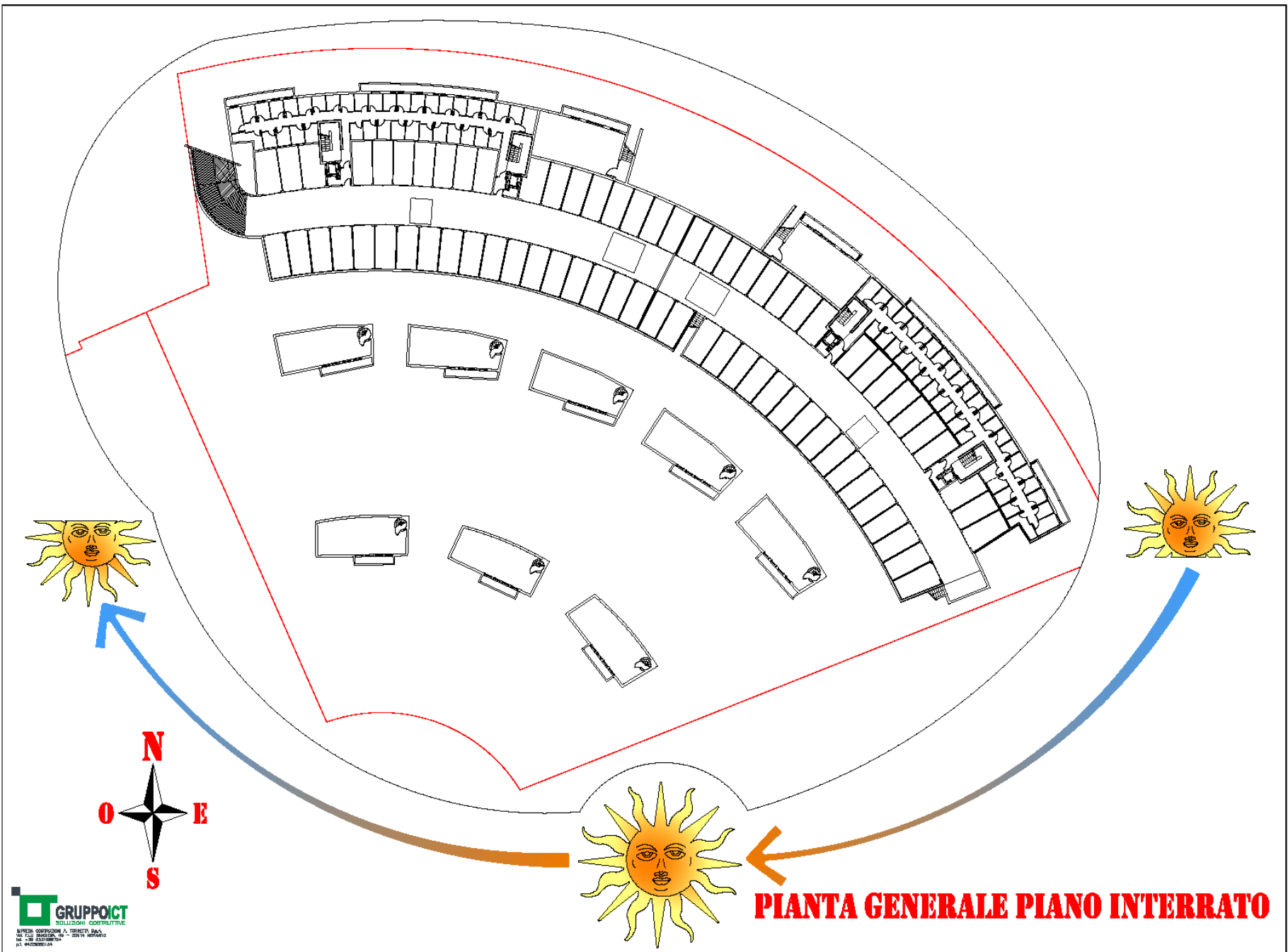

PIANTA GENERALE PIANO INTERRATO

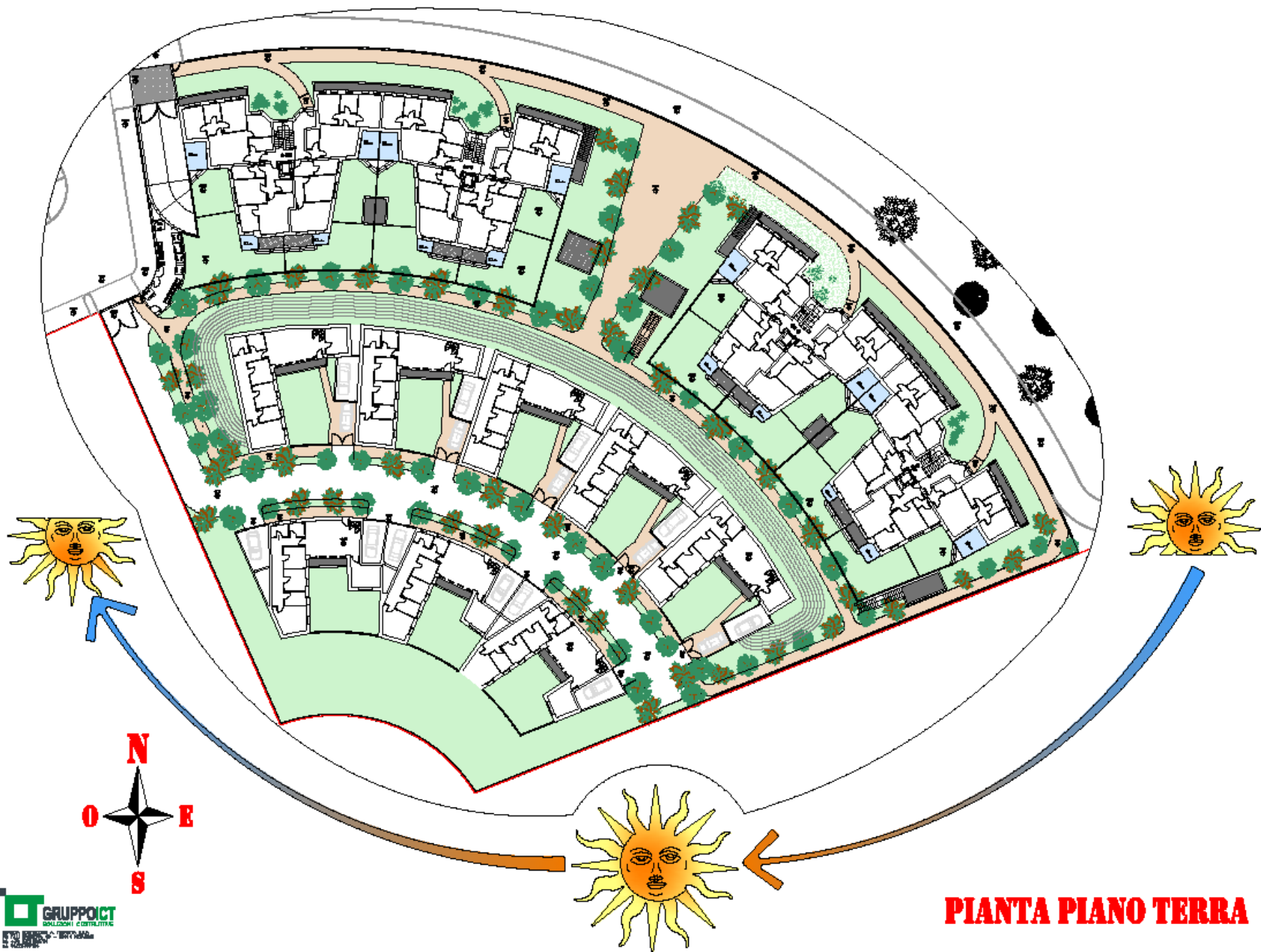

PIANTA PIANO TERRA

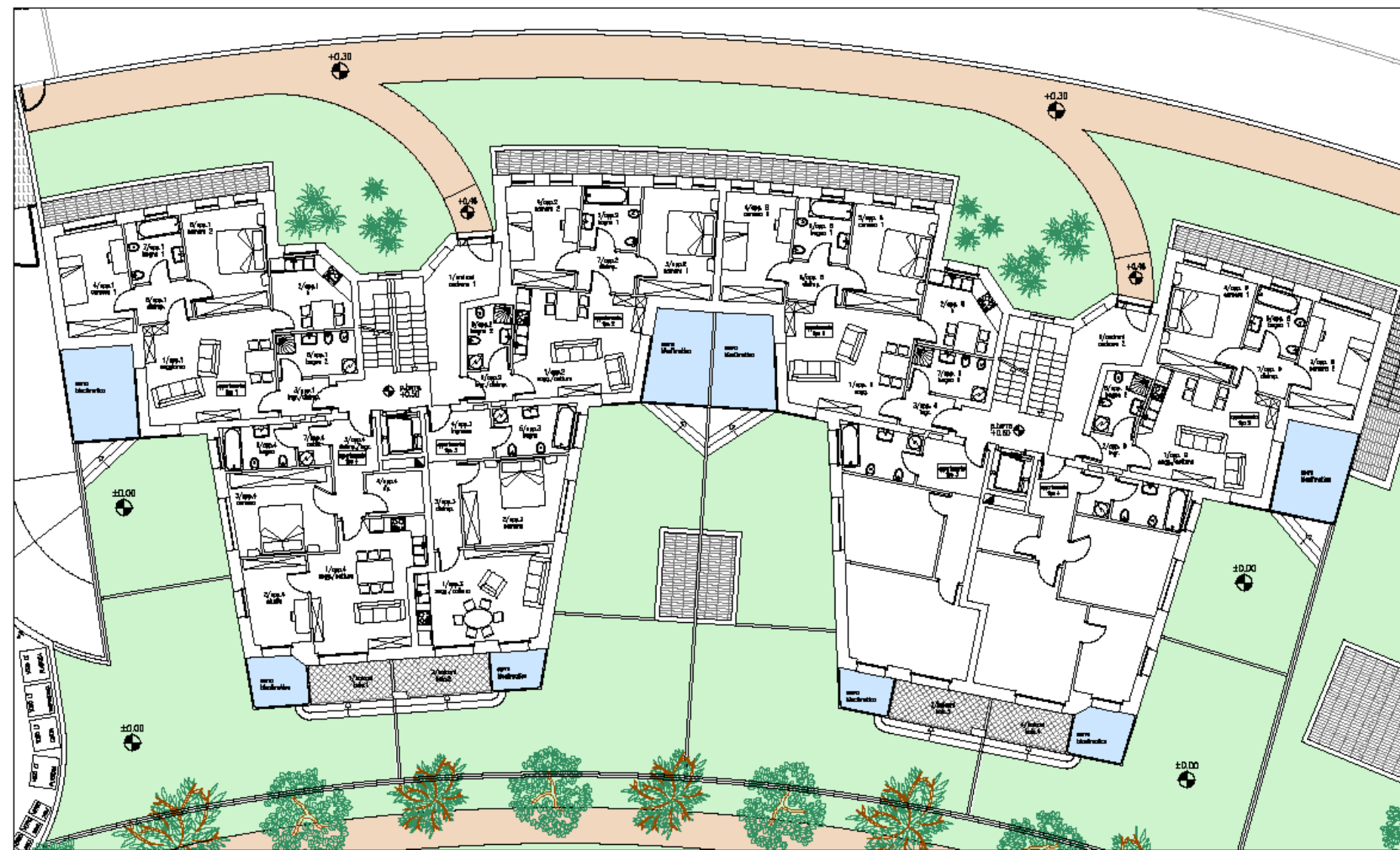

PIANTA PIANO TERRA PALAZZINA "A"



PIANTA PIANO TERRA VILLETTA INTERNA



PIANTA PIANO TERRA VILLETTA ESTERNA

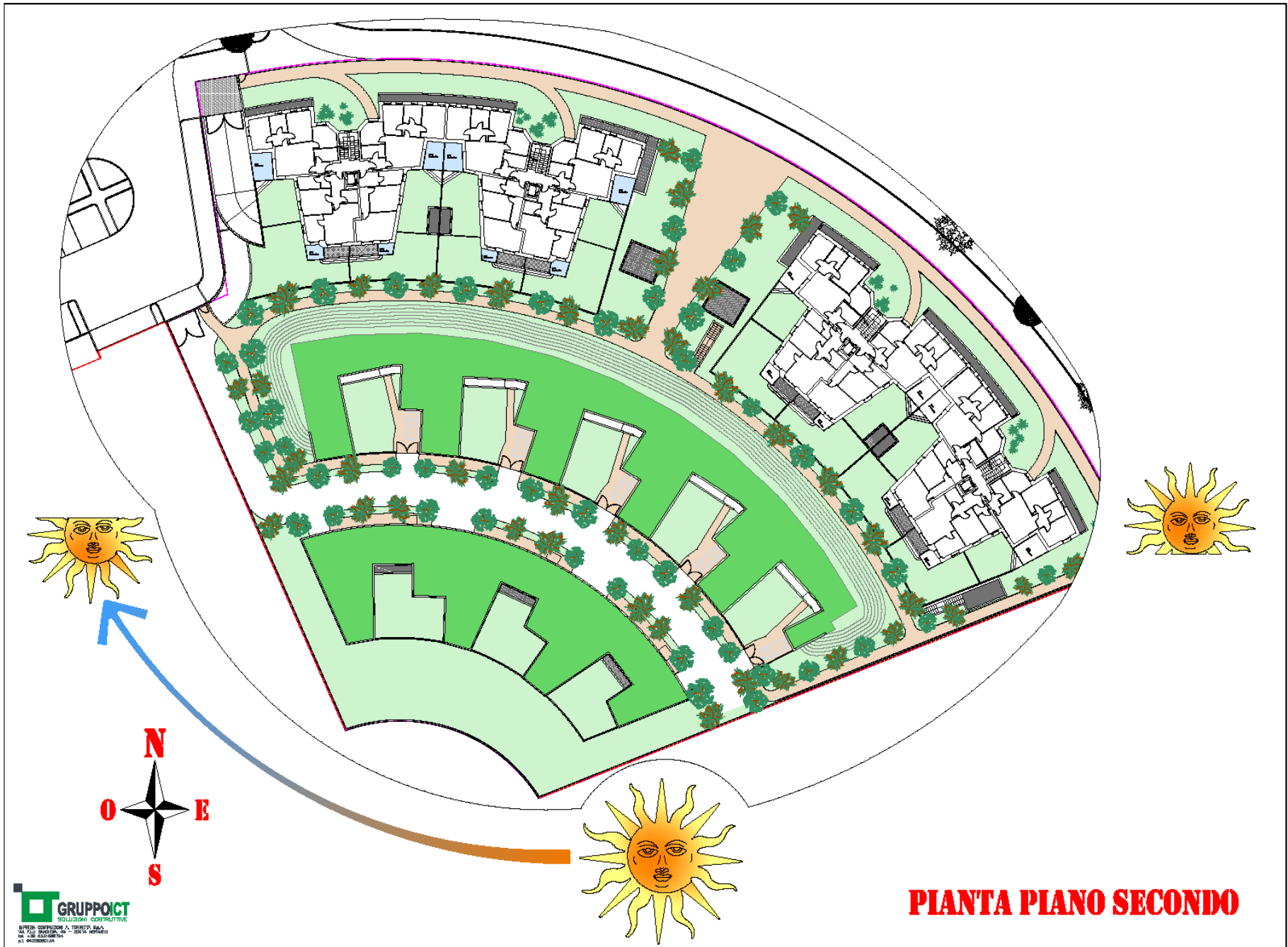

PIANTA PIANO SECONDO

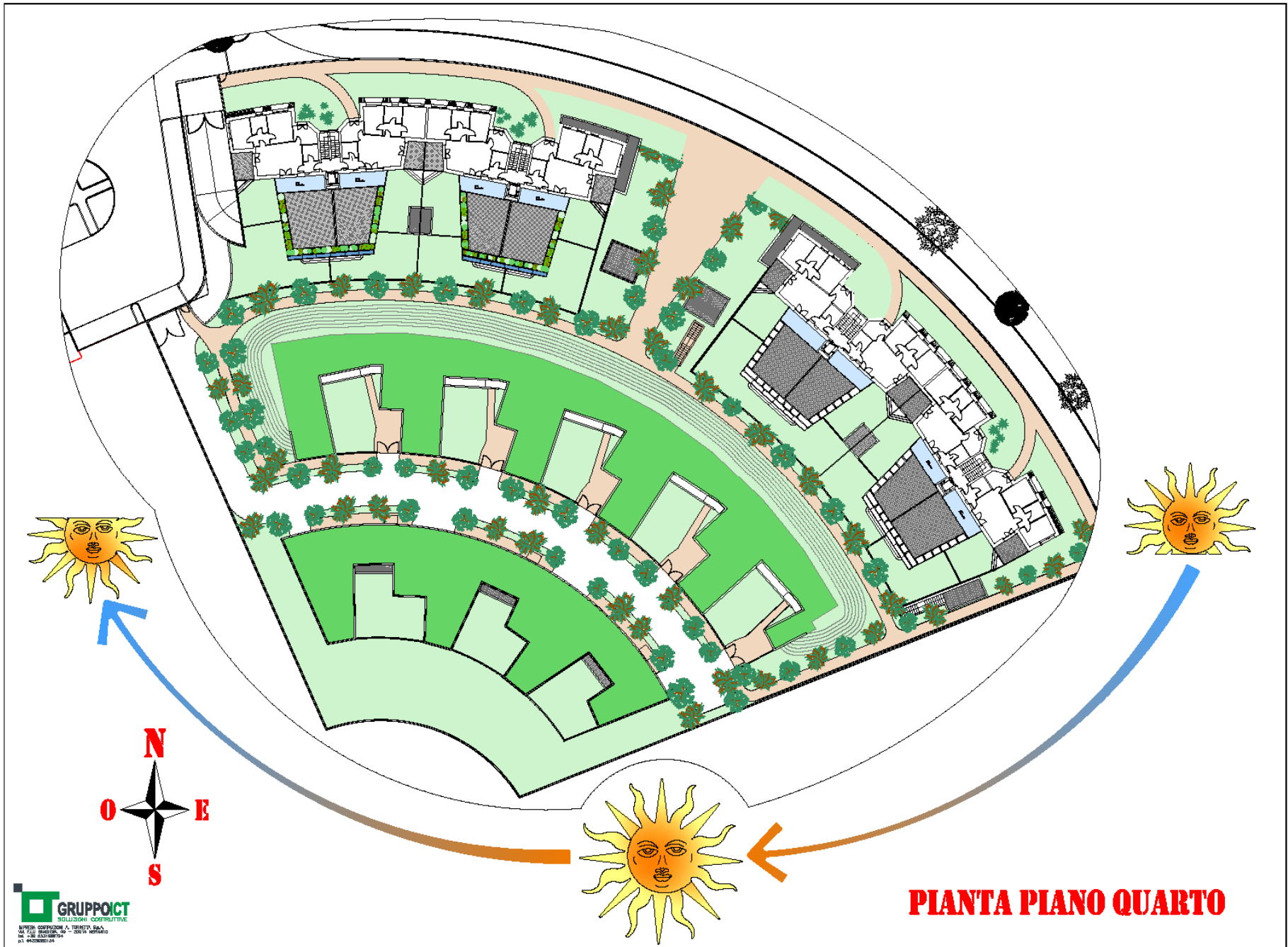

PIANTA PIANO QUARTO

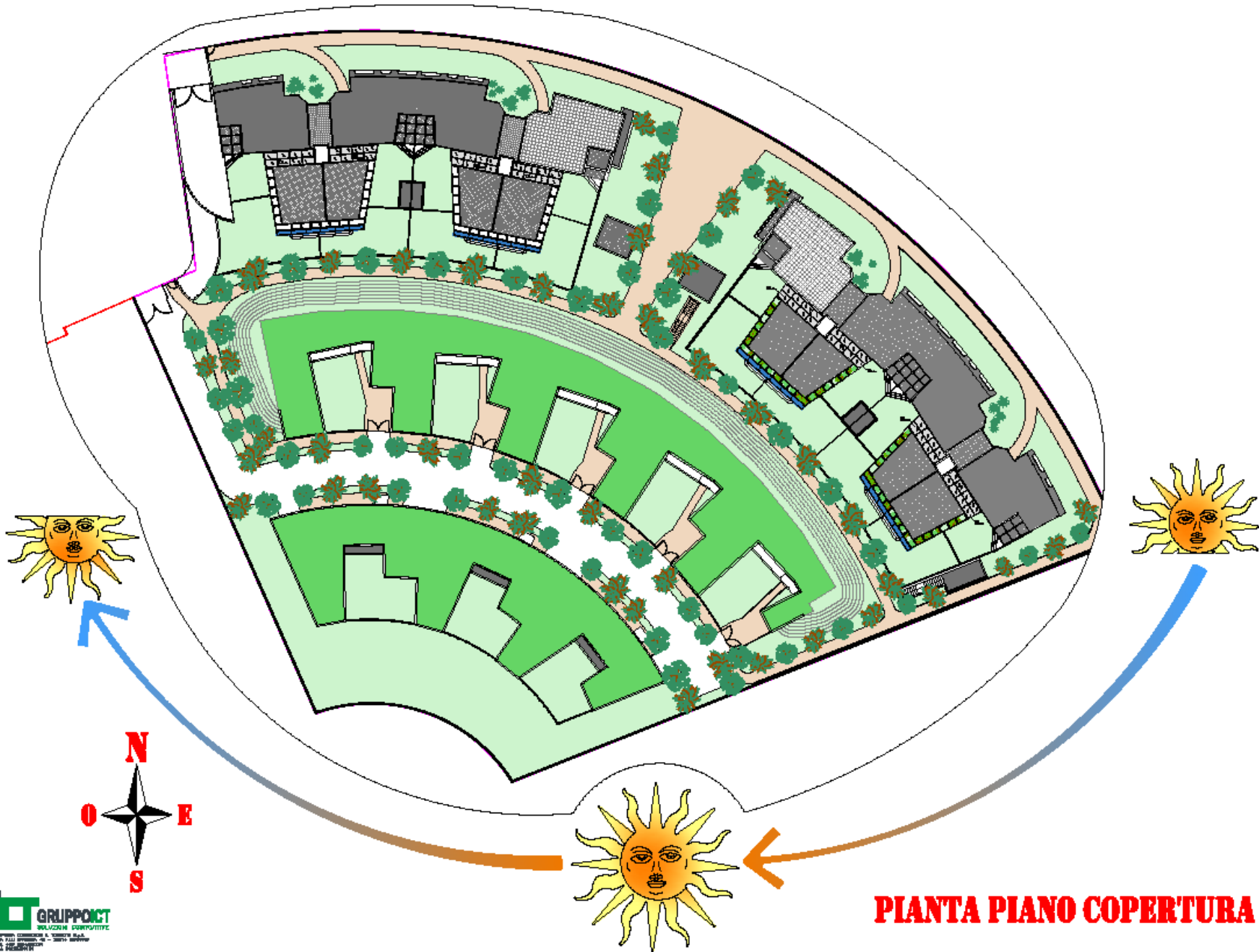

PIANTA PIANO COPERTURA

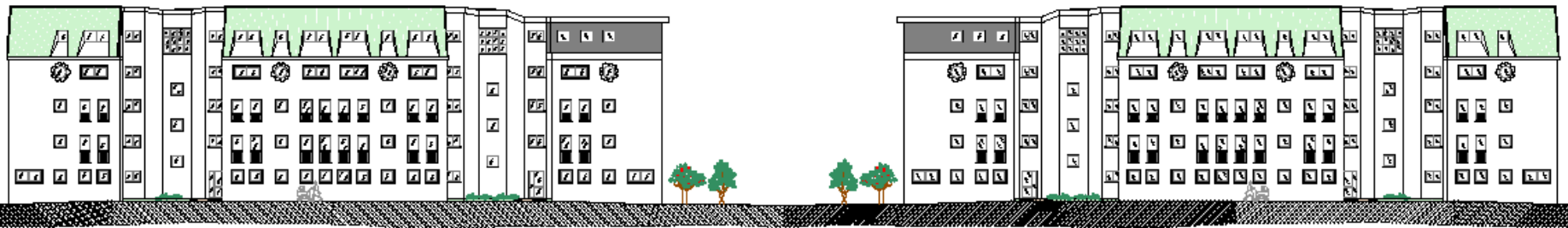

PROSPETTO EDIFICI LATO NORD



PROSPETTO EDIFICI LATO SUD

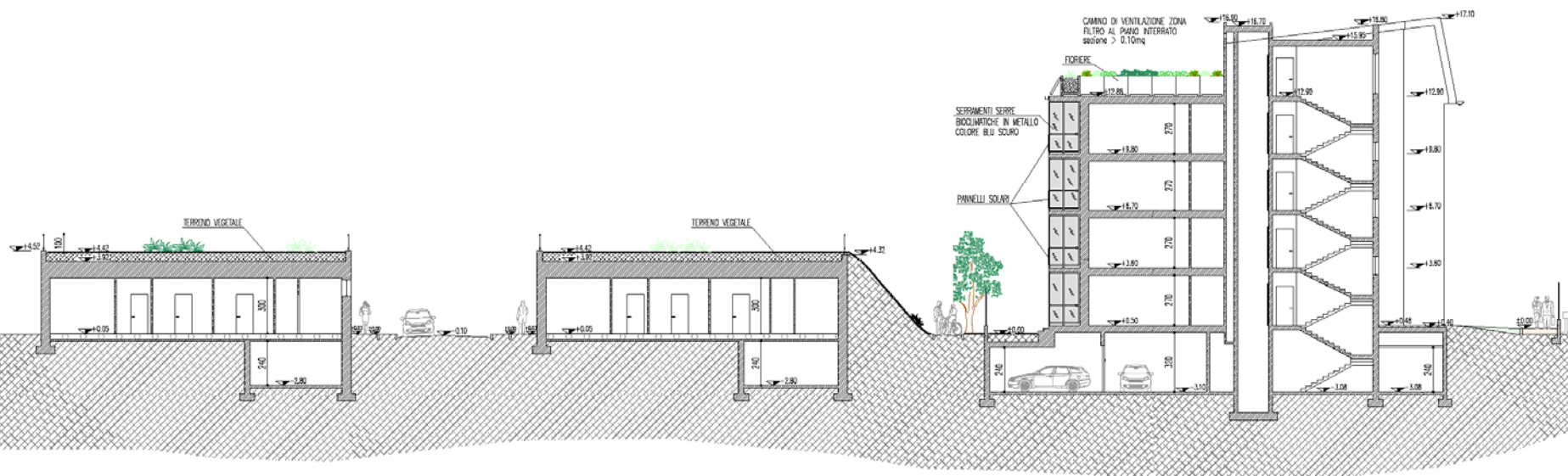

SEZIONI A-A

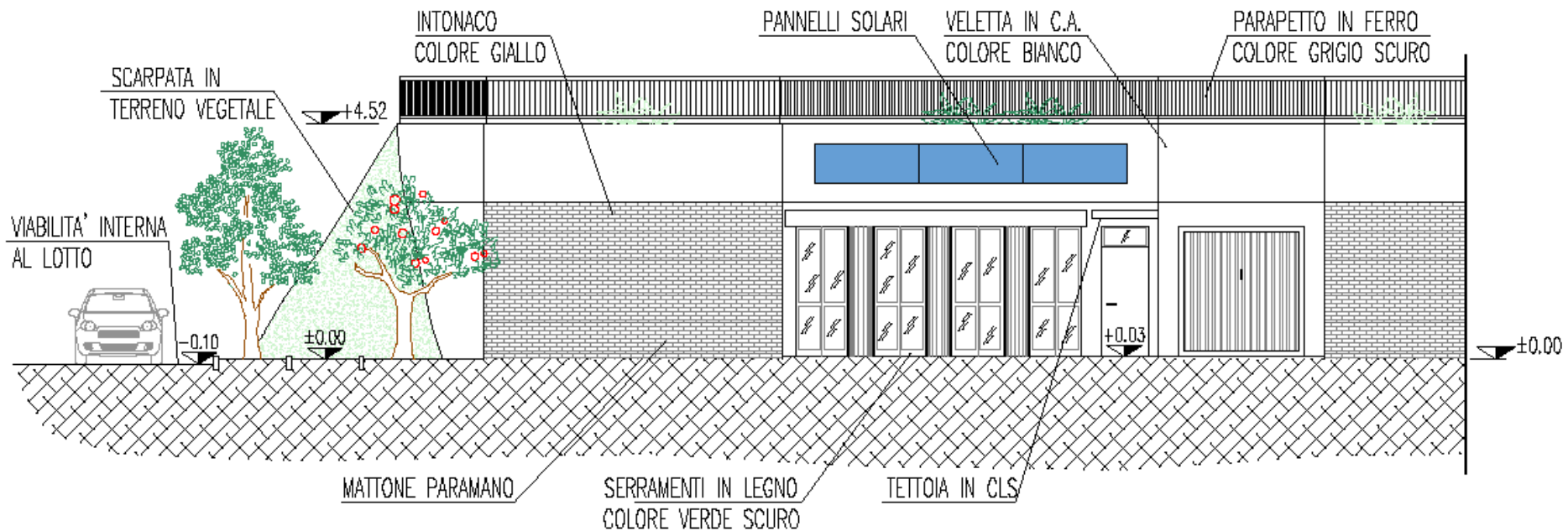

PROSPETTO VILLA INTERNA LATO SUD

PARTICOLARE A

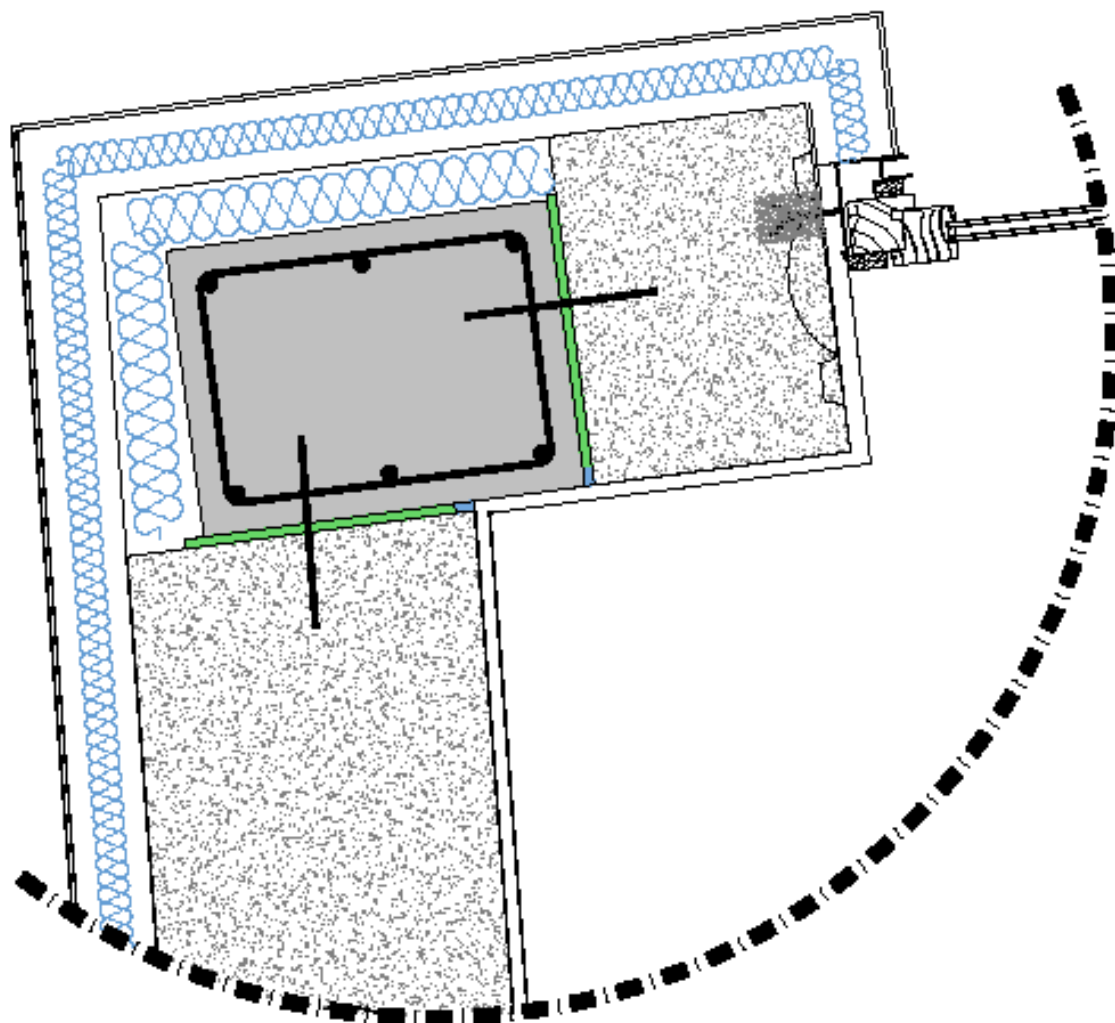

PARTICOLARE D (CORREZIONE PONTE TERMICO SOLETTE)

SEZIONE

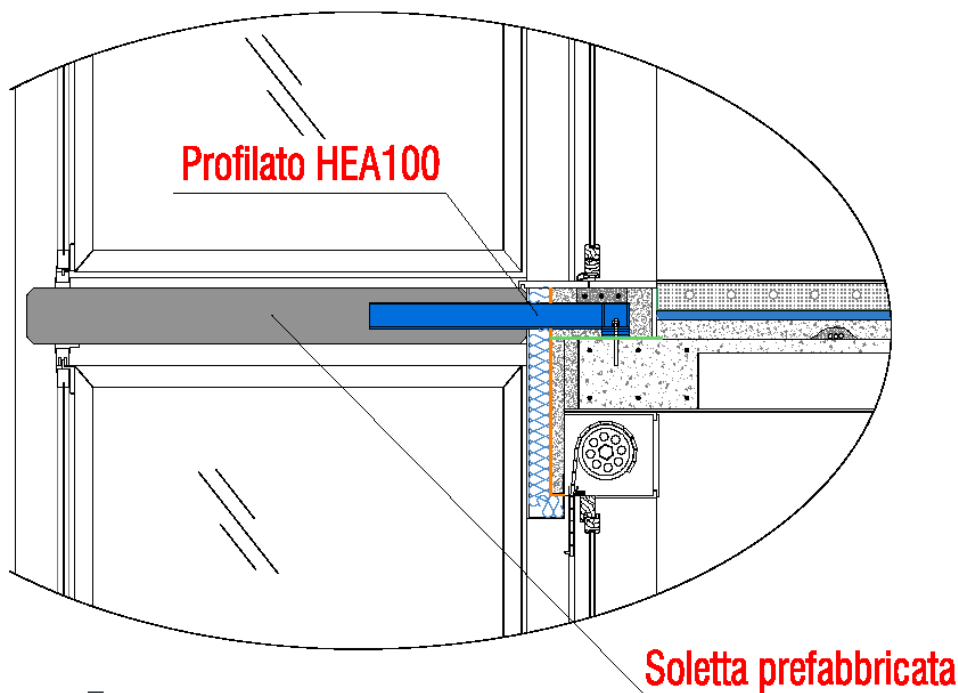

PIANTA

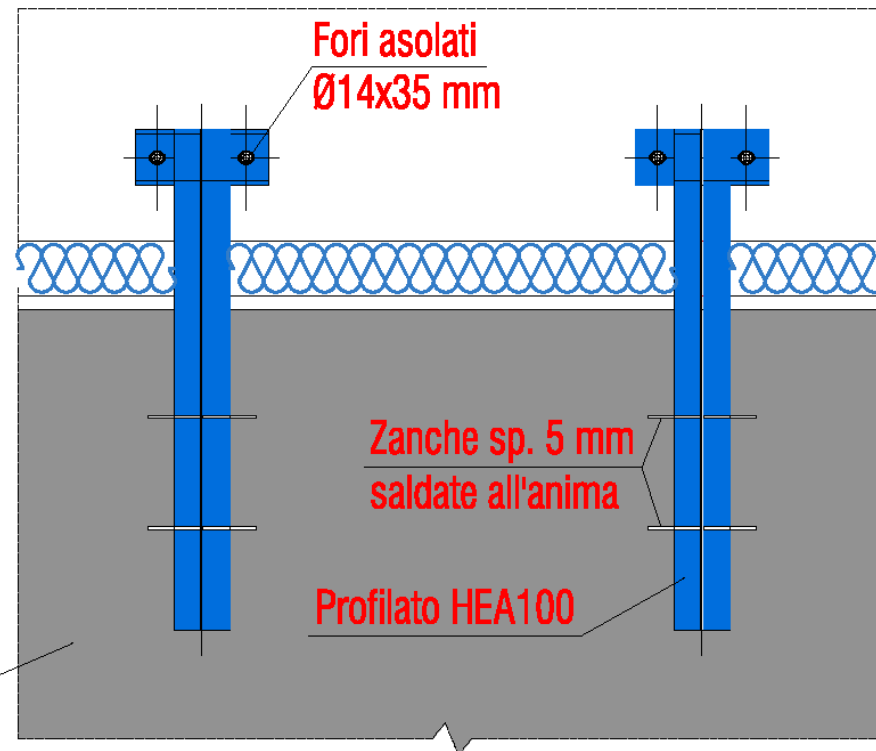

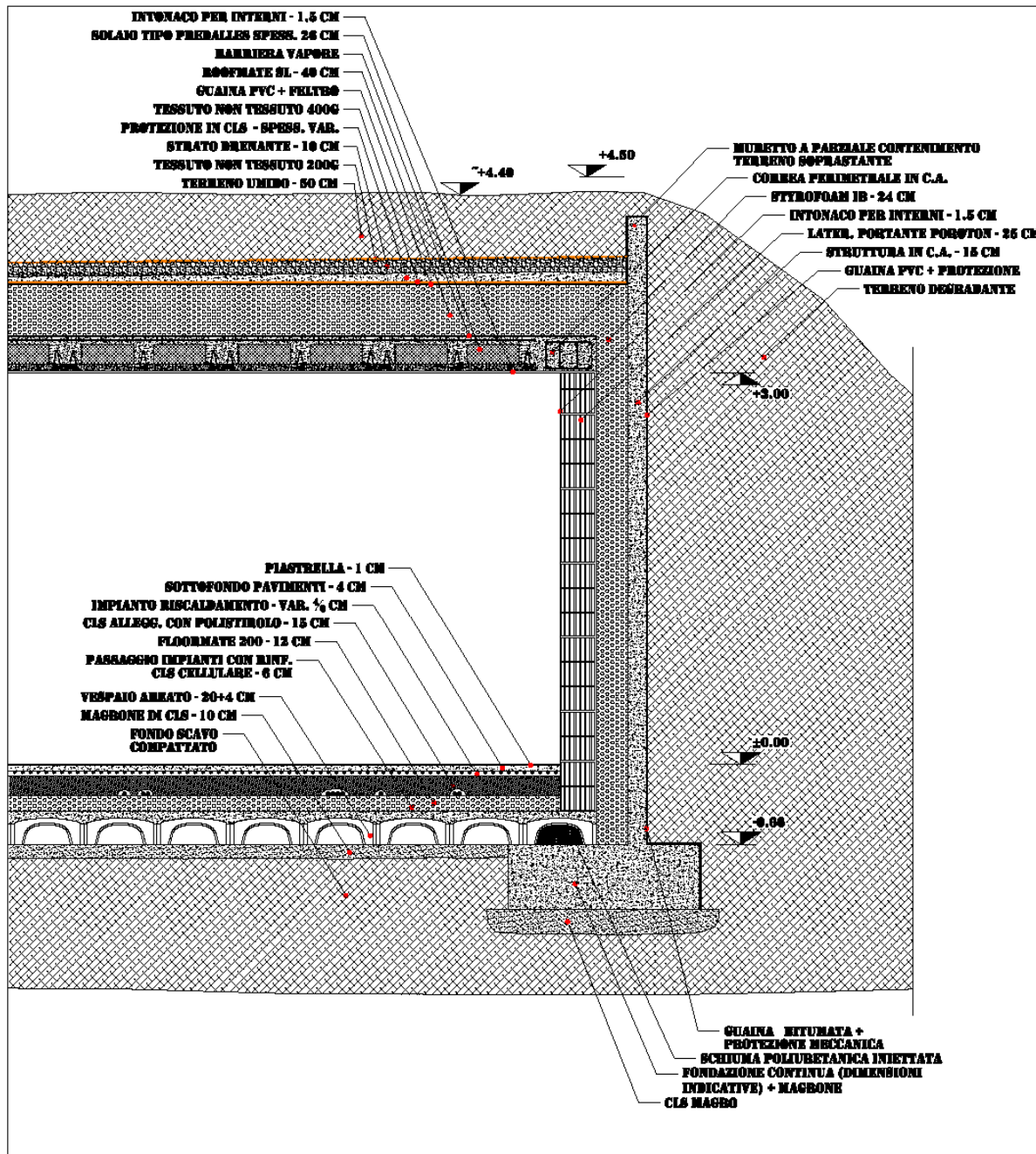

MURATURA CONTRO TERRA

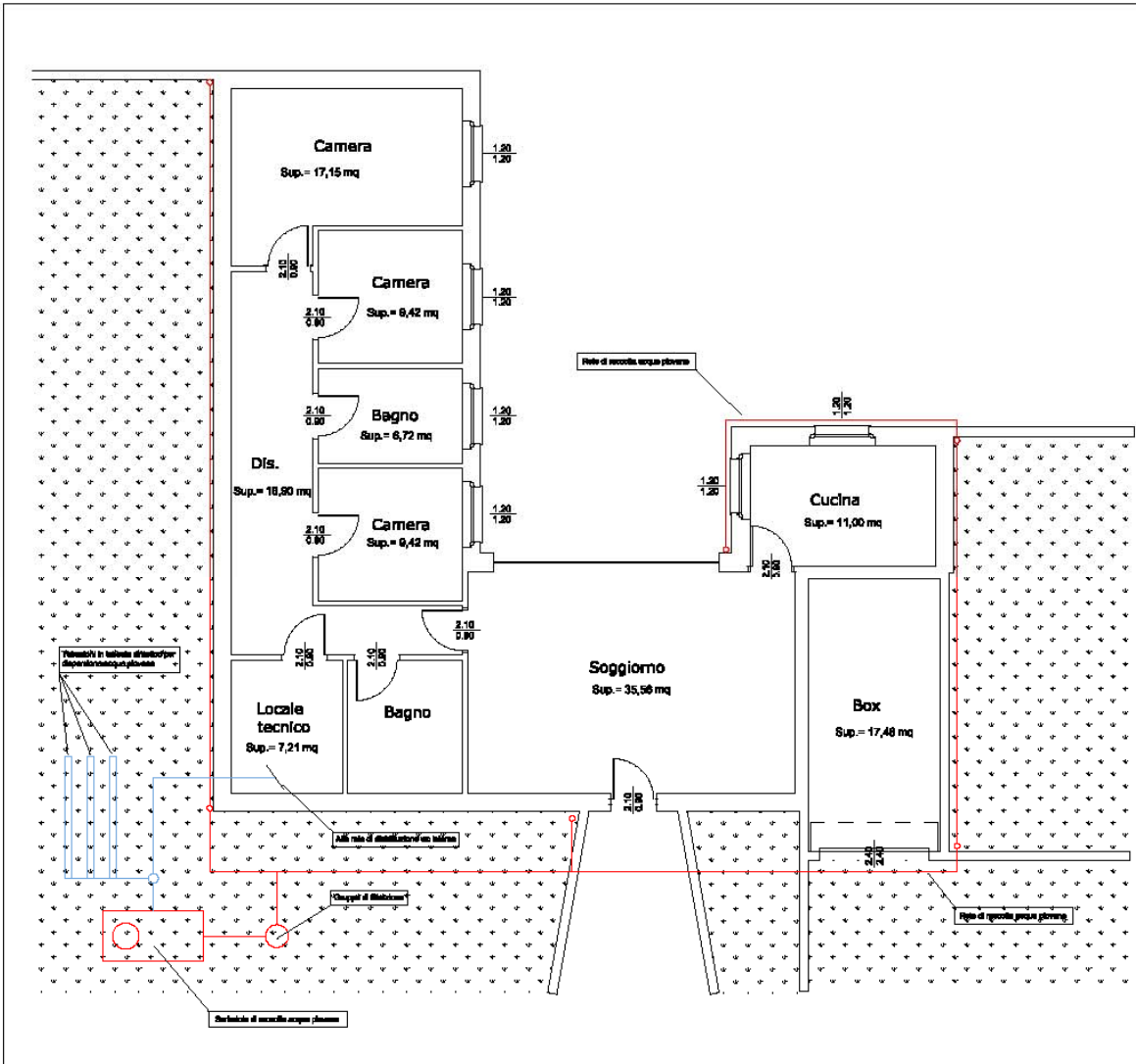

SCHEMA RETE DI RACCOLTA ACQUE METEORICHE

RAPPRESENTAZIONE DEL SISTEMA RECUPERO ACQUE PIOVANE

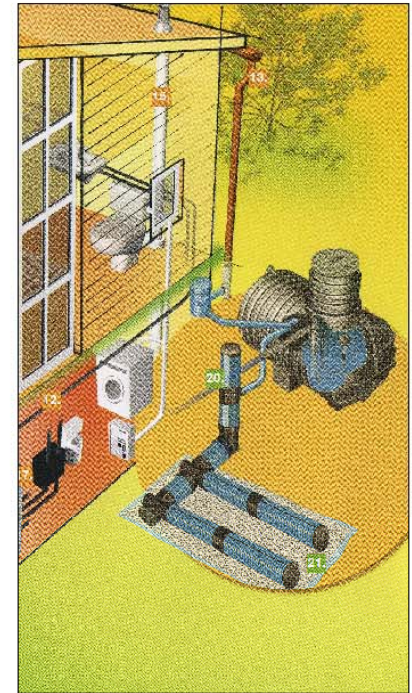

SERBATOIO INTERRATO DI RACCOLTA

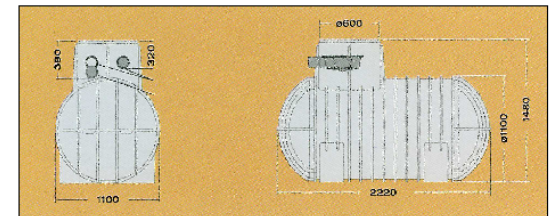

COMPONENTI DEL SISTEMA DI VENTILAZIONE MECCANICA CONTROLLATA

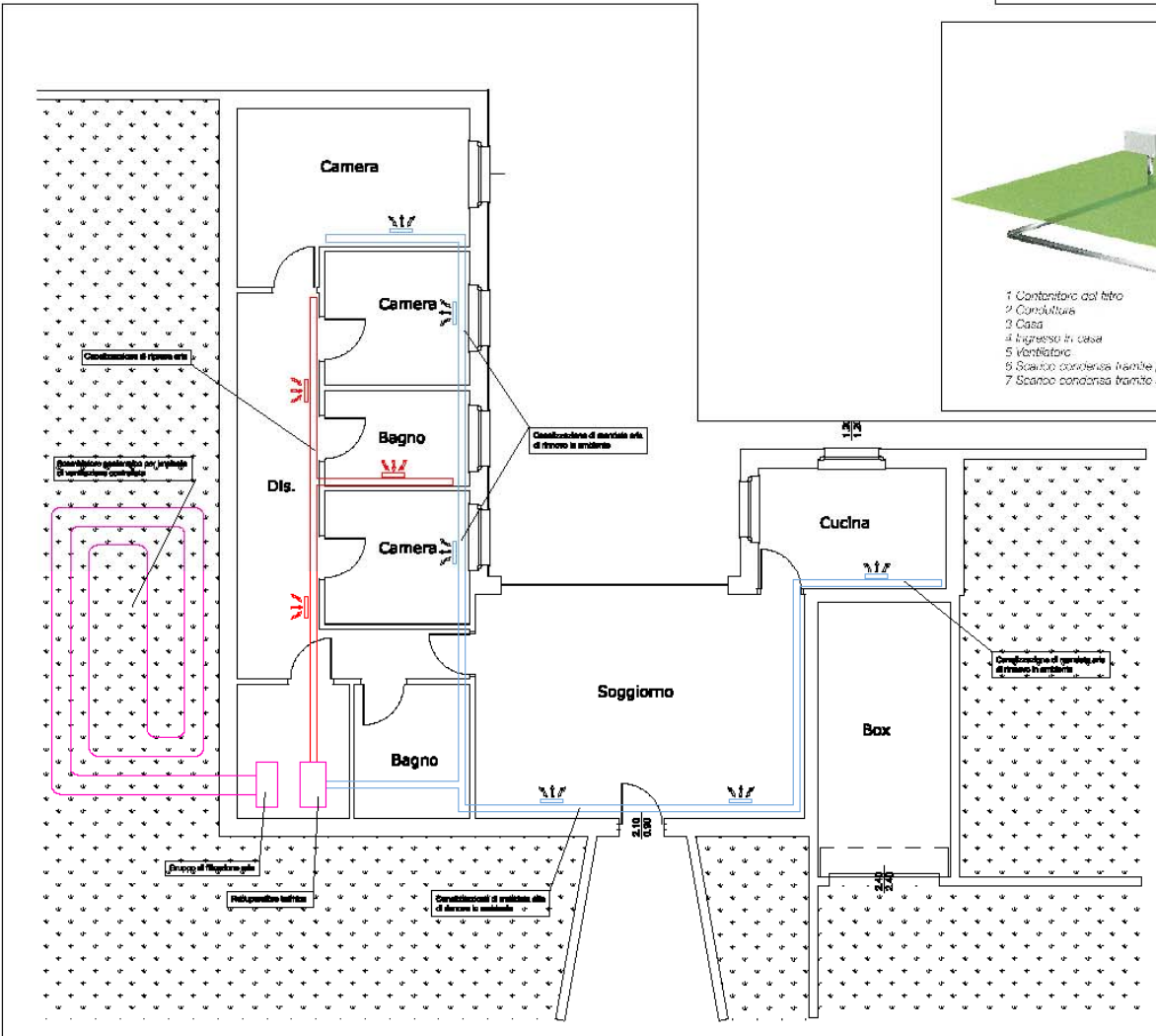
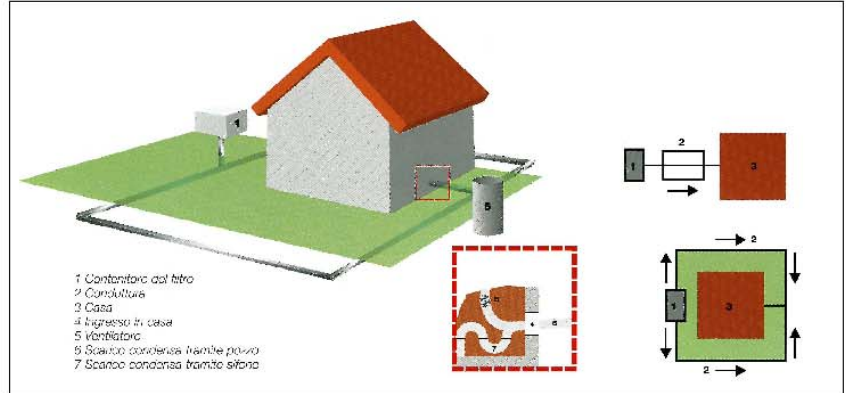

CONDIZIONI DI FUNZIONAMENTO DELLO SCAMBIATORE GEOTERMICO

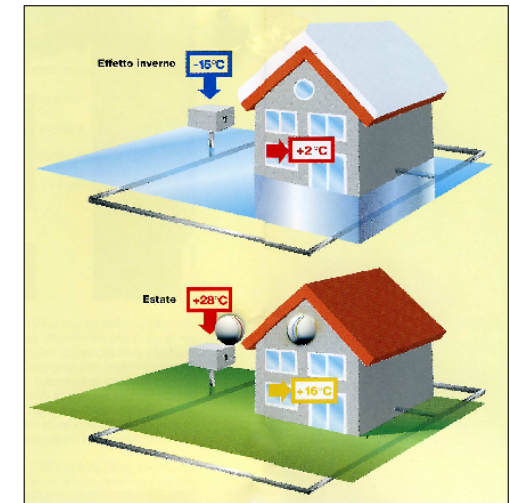

SCHEMA GENERALE SISTEMA DI VENTILAZIONE CONTROLLATA CON SCAMBIATORE GEOTERMICO E RECUPERO DI CALORE













